

UNI-T®



UT276A/278A

Operating Manual



Clamp Earth Groud Testers

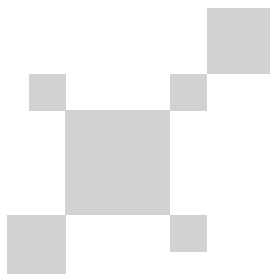

P/N:110401104578X
DATE:2018.06.26
REV.3

Contents

I、 Safety Instructions	1
II、 Product Overview	3
III、 Unpack and Check	4
IV、 Product Specification	5
1、 Series Types	5
2、 Range and Accuracy	6
3、 Technical Specification	7
V、 Clamp Meter Structure	9
VI、 Liquid Crystal Display	10
1、 Liquid Crystal Display	10
2、 Instruction for Special Symbol	11
3、 Display Demonstration	12
VII、 Operation Methods	16
1、 Power-on	16
2、 Power-off	18
3、 Resistance Measurement	18
4、 Current measurement	21
5、 Data hold/unlock/store	22

6、Data Inquiry	24
7、Alarm Function Setting	25
8、Alarm Critical Value Inquiry	26
9、Data Wipe	27
10、Data Uploading to Computer	27
VIII、Measurement Principles	28
1、Resistance Measurement Principle	28
2、Current Measurement Principle	29
IX、Ground Resistance Measurement Method	30
1、Multi-point Ground System	30
2、Limited Point Ground System	31
3、Single Point Ground System	33
X、On-site Application	38
1、Application of Power System	38
2、Application of Telecommunication System	39
3、Application of the building lightning protection ground system	41
4、Application of the gas station ground system	42
XI、Notes about Ground Resistance Measurement	46
Appendix: loop Resistance Analysis	50

I、Safety Instructions

Thank you for purchasing the Clamp-on Ground Resistance of our company and for the full use of the product, please:

- **Read the user manual carefully.**
- **observe the operation notes listed in the manual.**

- Under no circumstances shall fail to pay attention to the safety in using the clamp meter.
- Pay attention to the stipulate measurement scope and operation environment.
- The instrument shall apply to ground resistance testing instead of the current of power frequency power wire, or it will affect the clamp's magnetic property and the accuracy of ground resistance testing finally.
- Pay attention to the labeled words on the surface board and backboard.
- Before start it, pull the trigger once or twice to confirm the jaw of clamp can close or open freely.
- When starting it, don't pull the trigger and clamp any wires.
- Clamp the objects being tested only after displaying the sign “OL Ω” after started the instrument.

- Contact surface of the clamp jaw shall keep clean and refrained from cleaning by corrosive and coarse matters.
- Refrain from any shock on the clamp meter, especially the junction surface of the clamp jaw.
- It is strongly recommended using our company's explosion-proof Clamp-on Ground Resistance tester in dangerous occasions.
- The explosion-proof product is prohibited to dismantle and replace the battery in dangerous place.
- The clamp meter shall sound sporadically with light “hum” in measuring the resistance, which is normal and shall be distinctive from the warning sound “beep--beep--beep--” .
- Do not exceed the upper limits of the clamp meter in measuring the wire's current.
- Take out battery if do not use it for long time.
- Dismantling, calibration and maintenance of the clamp meter shall be conducted by the authorized qualified personnel.
- If any danger might be resulted in continuation use by the inner reason of the meter, stop using it immediately and pack it to the authorized qualified

- institution to address the problem.
- The contents labeled with “ * ” in the user manual shall be only applicable to UT278A.

II、 Product Overview

The series of clamp-on ground resistance tester represents a significant breakthrough of the traditional ground resistance measurement techniques and apply widely to grounding resistance measurement in electricity, telecommunication, meteorology, oilfield, architecture and industrial electric equipment.

In measuring the ground system with loop, the series of clamp-on ground resistance tester don't need to disconnect the ground down lead and any auxiliary electrode, safe and fast, easy to use.

The series of clamp-on ground resistance tester can measure the grounding problems with the traditional methods and apply to occasions traditional ways can't measure as the tester measure the composite value of the grounding body resistance and grounding down lead resistance.

UT276A、 278A clamp-on ground resistance tester is the medium and high-end

Product in the UT270 clamp-on ground series, its uniqueness are:

No long time waiting for start up, enter into testing immediately.

The only one clamp-on ground resistance meter with RS232 port, uploading the stored data to PC.

A breakthrough of the relay self-checking method, adopt the advance arithmetic and digital IC processing techniques.

Solving the bulkiness of old product, and meeting the portable meter property.

Add the sound-light alarm function with “beep--beep--beep--”

Add the recognition indication function of interference signal with “beep--beep--beep--” .

Measurement scope has increased to $0.01\ \Omega$ - $1200\ \Omega$.

With 99-group storage data, lower energy consumption, and with working current less 50mA in maximum start up.

III、Unpack and Check

Unpack and take out the instrument, please check carefully if the following attachment are complete or intact, if any lack or damage were found, please

contact with your supplier.

Meter	1
Test ring	1
Data up-loading software disk	1
RS232 communication wire	1(1.8m)
R6 (AA size) dry batteries	4
Meter box	1
User manual, warranty, qualification certificate	A set

IV、Product Specification

1、Series Types

Types	Measuring resistance	Measuring current	Storing data	RS232 port	Warning function
UT276A	Yes	No	Yes	Yes	Yes
UT278A	Yes	Yes	Yes	Yes	Yes

2、 Range and Accuracy

Measurement mode	Measurement Scope	Resolution	Accuracy
Resistance	0.010 Ω - 0.099 Ω	0.001 Ω	± (1% + 0.01 Ω)
	0.10 Ω - 0.99 Ω	0.01 Ω	± (1% + 0.01 Ω)
	1.0 Ω - 49.9 Ω	0.1 Ω	± (1% + 0.1 Ω)
	50.0 Ω - 99.5 Ω	0.5 Ω	± (1.5% + 0.5 Ω)
	100 Ω - 199 Ω	1 Ω	± (2% + 1 Ω)
	200 Ω - 395 Ω	5 Ω	± (5% + 5 Ω)
	400 - 590 Ω	10 Ω	± (10% + 10 Ω)
	600 Ω - 880 Ω	20 Ω	± (20% + 20 Ω)
	900 Ω - 1200 Ω	30 Ω	± (25% + 30 Ω)
*Current	0.00mA - 9.95mA	0.05mA	± (2.5% + 1mA)
	10.0mA - 99.0mA	0.1mA	± (2.5% + 5mA)
	100mA - 300mA	1mA	± (2.5% + 10mA)
	0.30A - 2.99A	0.01A	± (2.5% + 0.1A)
	3.0A - 9.9A	0.1A	± (2.5% + 0.3A)
	10.0A - 30.0A	0.1A	± (2.5% + 0.5A)

3、 Technical Specification

Resistance range	0.01 Ω - 1200 Ω
*Current range	0.00mA - 30.0A
Resistance resolution	0.001 Ω
*Current resolution	0.05mA
Data storage	99groups
RS232 port	To upload stored data into the computer for data analysis.
Communication wire	RS232communication wire with 1.8m long.
Sound-light alarm	“beep--beep--beep--” alarm, press AL key to control the on-off status.
Scope of alarm critical value setting	Resistance : 1-199 Ω ; *current : 1-499mA
Power	6VDC (4 AA dry alkaline batteries)
Working temperature and humidity	0°C-55°C ; 10%RH-90%RH
LCD	4bit LCD digit display, dimension (47mm×28.5mm)

Clamp jaw dimension	65mm×32mm
Clamp jaw stretch size	28mm
Clamp surface mass	1160g (inclusive of battery)
Clamp surface dimension	Length, width and height 285mm×85mm×56mm
Protection rate	Double insulation
Structural characteristic	Clamp CT
Shift	Full automatic shift
Outside magnetic field and electric field	<40A/m; <1V/m
Single measurement time	0.5s
Resistance measurement frequency	>1KHz
*Frequency of the current being measured	50/60Hz (automatic)

V、Clamp Meter Structure

- 1、Long clamp head: 65×32mm
- 2、Trigger: control the closure and open of clamp jaw
- 3、Function keys
 - ⓘ ke key: (described as key POWER) power on and off/exit
 - SAVE key: data inquiry/wipe data
 - AL alarm function key: alarm function on/off
 - Left/right arrow key: resistance/current mode conversion
- 4、HOLD key: hold/unhold display/store
- 5、LCD
- 6、RS232 port

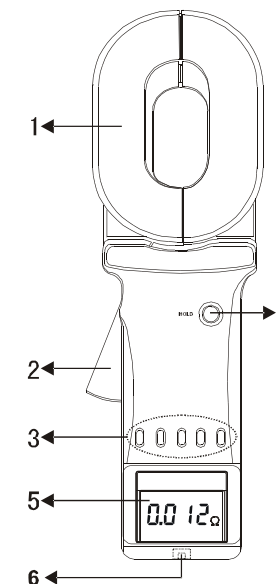

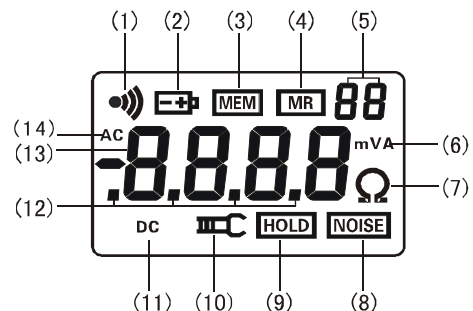

VI. Liquid Crystal Display

1. Liquid Crystal Display



(1)、	Alarm symbol	(8)、	Noise signal
(2)、	Battery low voltage symbol	(9)、	Data hold symbol
(3)、	Full stored data symbol	(10)、	Clamp jaw open symbol
(4)、	Data inquiry symbol	(11)、	DC symbol
(5)、	Number of 2-bit stored data group	(12)、	Decimal point
(6)、	Current, voltage unit symbol	(13)、	4-bit LCD digital display
(7)、	Resistance unit symbol	(14)、	AC symbol

2. Instruction for Special Symbol

- (1)、  clamp jaw open symbol. It shall display when the clamp jaw is open. It indicates that it might be artificial pull-off the trigger; or the clamp jaw has been too dirty to measure, requiring clamp jaw cleaning.
- (2)、 “Er” : power-on error symbol. It might be caused by the dirtiness of the clamp jaw, please clean the clamp jaw surface.
- (3)、  battery low voltage symbol. When the battery voltage is lower than 5.3V, the symbol would appear and replace battery in time or the measurement accuracy couldn't be guaranteed.
- (4)、 “OL Ω” symbol, it means the resistance being measured exceeds the upper limit of the clamp meter.
- (5)、 “L0.01 Ω” symbol, it means the resistance being measured exceeds the lower limit of the clamp meter.
- (6)、 “OL A” symbol, it means the current being measured exceeds the upper limit of the clamp meter.
- (7)、  Alarm symbol, when the measured value exceed the alarm critical value, it will flicker and the meter will sound sporadic “beep--beep--beep--” .

- (8)、**MEM** full stored data symbol, when the stored data has reached 99 groups and can't store data anymore, the symbol **MEM** shall flicker.
- (9)、**MR** Data inquiry symbol, it shall appear in inquiring data and indicate the No. Of stored data.
- (10)、**NOISE** Symbol, when there are quite big interference current to the earth loop being measured, the symbol shall flicker and the meter sound sporadic "beep--beep--beep--", the measurement accuracy of the time can't be guaranteed.

3、Display Demonstration

- (1)、as clamp jaw is open, it can't measure.
(It might be caused by the dirtiness of the clamp jaw, please clean the clamp jaw surface.)

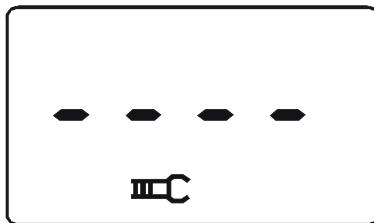

- (2)、power-on error indication Er(Error)
(It might be caused by the dirtiness of the clamp jaw, please clean the clamp jaw surface.)



- (3)、resistance of the loop being measured <math><0.01 \Omega</math>



- (4)、resistance of the loop being measured is 5.1 Ω



- (5)、
- resistance of the loop being measured is $2.1\ \Omega$,
 - hold the present measurement value: $2.1\ \Omega$,
 - store automatically as the No.08 group data.

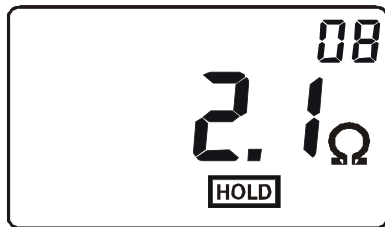

- (6)、
- inquiry the No.26 group stored data
 - resistance of the loop being measured is: $0.028\ \Omega$

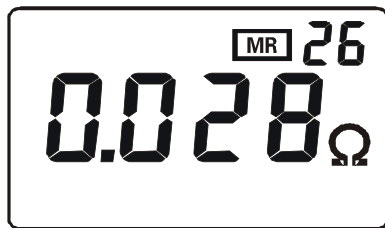

- (7)、
- start alarm function and the current being measured exceed the set alarm critical value
 - battery low voltage display and the measurement accuracy can't be guaranteed.
 - current being measured is: 8.40A
 - hold the present display value
 - store the present hold value as the No 37 group data.

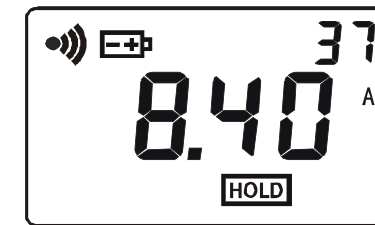

- (8)、
- inquiry No 08 group stored data
 - resistance being measure is: $30.0\ \Omega$
 - the data is measured under strong interference signal

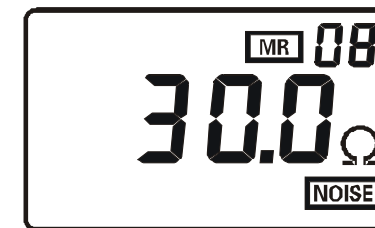

VII、 Operation Methods

1、 Power-on

⚠ Notes:

- When starting it, don't pull the trigger, open the clamp jaw and clamp any wires.
- pull the trigger, open the clamp jaw and clamp wires only after power-on and display the "OL Ω "
- Before power-on, pull the trigger once or twice to confirm the clamp jaw can close or open freely.

When power-on, keep the clamp meter static, no turning and no force on the clamp jaw or the measurement accuracy can't be guaranteed.

Press the key POWER, check the LCD automatically and symbols shall appear as shown in picture1. Meanwhile, the meter calibrate automatically, after power-on, it shall display "OL Ω " and enter automatically into the resistance measurement mode, as shown in picture2. If automatic calibration under improper power-on, the meter will display the symbol "Er" indicating error occurs in power-on, as shown in picture3.

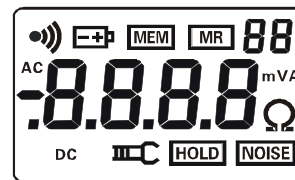

Picture 1



Picture2

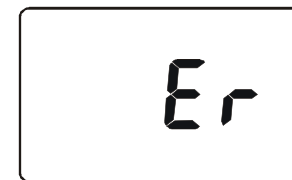

Picture 3

The power-on error might be resulted by the bad closure of clamp jaw or by the dirt on the clamp jaw surface, please clean it.

If after the power-on self check, it appears a big resistance instead of "OL Ω ", as shown in picture 4. It might be resulted by the bad closure of clamp jaw or by the dirt on the metal surface, please clean it.



Picture 4

If the result is correct in detection by the test ring, it represents that the clamp meter have big error just in measuring high resistance (>100 Ω), and remain

original accuracy in measuring low resistance, user can use it with assurance.

2、 Power-off

Press key POWER to power-off after power-on.

After working 5 minutes, the LCD shall flicker continuously about 30seconds and then power-off to reduce battery consumption. Press key POWER to delay power -off, the clamp meter shall continue working.

Under the **HOLD** status, press key **HOLD** to exit the status and press key POWER to power-off.

Under setting alarm critical value status, it is required to press key POWER or key AL 3 seconds to exit the status and press key POWER to power off.

3、 Resistance Measurement

If display “OL Ω” after power-on self check, you can measure the resistance.

Pull the trigger and open clamp jaw, clamp the loop being measured to read the resistance value.

*Users are required to test by random test ring as shown in picture 5.

The displayed value should be the same with standard value on the test ring (5.1Ω), which is the value under temperature 20℃.it is normal if there is a decimal difference between them, for instance, standard value of the test ring is 5.1Ω; the displayed value is 5.0Ω or 5.2Ω.

Display “OL Ω” it means the resistance being measured exceed the upper limit of clamp meter, as shown in picture 2.

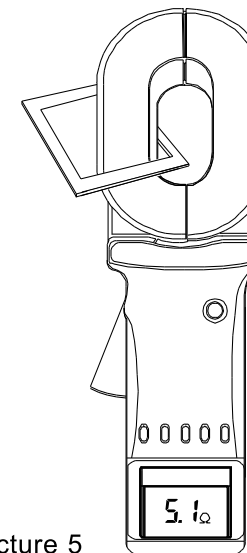

Picture 5

Display “L0.01Ω” it means the resistance being measured exceed the lower limit of clamp meter, as shown in picture6.



Picture 6

Flicker display «») symbol with sporadic “beep--beep--beep--” it means the resistance being measured exceed the resistance alarm critical value.

Under the **HOLD** status, press key **HOLD** to exit the status and press key **POWER** to power-off.

Under the **MR** status, press key **SAVE** to exit the status and continue to measure.

Under setting alarm critical value status, it is required to press key **POWER** or key **AL** 3 seconds to exit the status and continue to measure.

*Under the current test mode, press key Ω covert to the resistance test mode.

4、Current measurement

⚠ Notes:

the meter is mainly used for ground resistance test and the current measurement shall be only applicable to the current test on the ground wire but the power line or affect the magnetic property of the clamp head and finally affect the ground resistance test accuracy.

After power-on self check, clamp meter shall enter into the resistance measurement mode. After display the “OL Ω”, press key **A**, clamp meter enter into current measurement mode, displaying “AC 0.00mA” , as shown in picture 7. Pull the trigger, open the clamp jaw and clamp on the wire to read the current value.

“OLA” on the clamp meter, it means the current being measured exceed the upper limit of clamp meter, as shown in picture 8.

Flicker display «») symbol with sporadic “beep--beep--beep--” , it means the current being measured exceed the current alarm critical value.



Picture 7



Picture 8

Under the **HOLD** status, press key **HOLD** to exit the status and continue to measure.

Under the **MR** status, press key **SAVE** to exit the status and continue to measure.

Under setting alarm critical value status, it is required to press key **POWER** or key **AL** 3 seconds to exit the status and continue to measure.

Under the resistance test mode, press key **A** convert to the current test mode.

5、Data hold/unlock/store

Under the test mode, press key **HOLD** to hold the present value and when displaying the symbol **HOLD**, the hold value could be set as a group of data and

numbered automatically orderly and be stored. Press key **HOLD** to cancel hold, the symbol **HOLD** would disappear and continue to measure. Operate as the above steps; you can store 99 groups of data. If the memory is full, the symbol **MEM** will flicker.

As shown in picture 9, hold the measured resistance 0.016Ω , and store it as the No 01group data.

As shown in picture 10, hold the measured current 278mA and store it as the No 99 group data, then the memory is full, the symbol **MEM** will flicker.

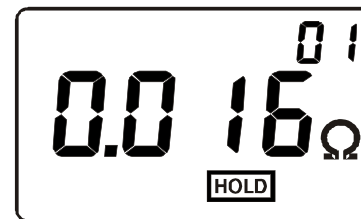

Picture 9

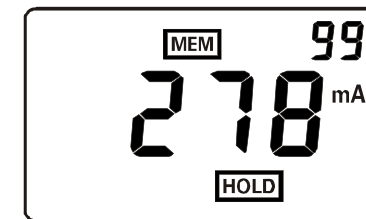

Picture 10

Under the data inquiry mode, press key SAVE to exit the data inquiry and hold, store the data.

Under setting alarm critical value status, it is required to press key POWER or key AL 3 seconds to exit the status and continue to hold and store data.

The stored data would not lose when power-on after power off the meter.

6、Data Inquiry

Press key SAVE to enter into the stored data inquiry mode and display the No 01 group stored data, as shown in picture 11. Then press the right arrow key, inquiry upward stored data or press the left arrow key to inquiry downward all stored data. If no stored data, it will display as shown in picture 12.

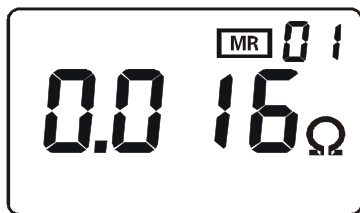

Picture 11

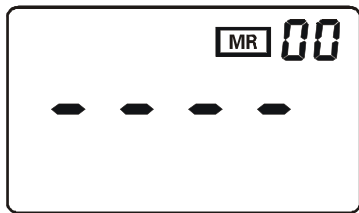

Picture 12

Under setting alarm critical value status, it is required to press key POWER to exit the status and press key SAVE to enter into the stored data inquiry mode.

7、Alarm Function Setting

Under the test mode, press key AL to open or close the alarm function.

Under the test mode, press key AL 3 seconds to enter into the alarm critical value setting function, and the highest digit number shall flicker; set the highest digit as shown in picture 13 and 14. Press key AL to convert the number on high digit and low digit. When the present digit number is flickering, press right and left arrow key to change the number “0,1, …9” after setting all numbers, press key AL 3 seconds to confirm the set alarm critical value. It means it is able to operate the alarm function and then back to the measurement mode automatically. If the load is bigger the alarm critical value, the meter shall display alarm symbol with sporadic sounds “beep--beep--beep--” .

During the set process, press key POWER to exit the alarm critical value setting function and back to the measurement status, without changing the previous set value.

Under the data inquiry mode, press key SAVE to exit the mode and to set the alarm critical value.

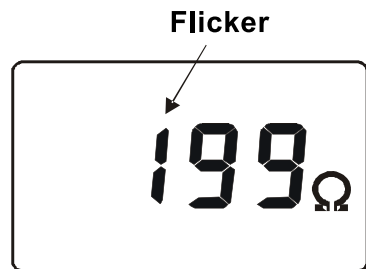

Picture13. Set the resistance alarm critical value

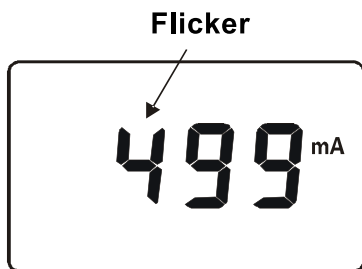

Picture14. Set the current alarm critical value

8、Alarm Critical Value Inquiry

Under the test mode, press key AL 3 seconds to inquire the alarm critical value, and the highest digit number shall flicker and each time inquired is the previous set value. Press key AL 3 seconds or key POWER to exit and check, back to measurement status. As shown in picture 15, the previous set resistance alarm critical value is 20Ω.

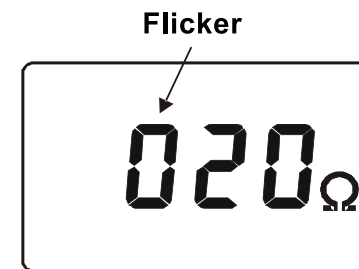

Picture 15

9、Data Wipe

Under the data inquiry mode, press key SAVE+POWER, automatically wipe all stored data, after it, meter shall display as shown in the picture 12, and all wiped data shall not be able to recover.

10、Data Uploading to Computer

Connect the meter host with computer with the RS233 communication wire deployed with the meter and the meter shall power on and operate software, select history check, and read, store and print the history data. The history data could be saved as Txt text or in the Excel format.

VIII、 Measurement Principles

1、 Resistance Measurement Principle

Basic principle of the clamp-on ground resistance meter in measuring the ground resistance is measuring the loop resistance (detailed in appendix).

Refer to the following picture; clamp jaw of the clamp is composed of voltage coil and current coil. The meter measures E and I , and know the measured resistance R by the following formula.

$$R=E/I$$

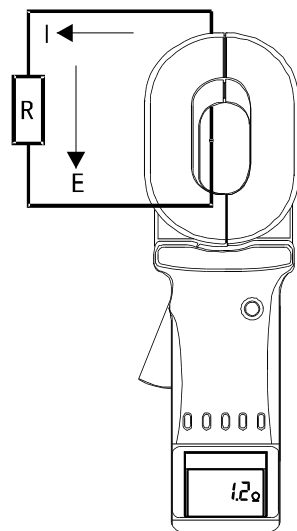

2、 Current Measurement Principle

The basic principle of UT278A clamp-on ground resistance meter is the same with that of current transformer measurement.

Conductor being measured

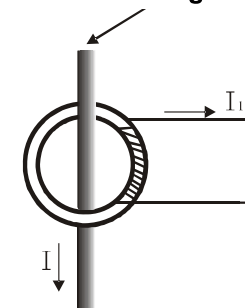

The AC current I of the measured wire, passing through the current magnetic ring and current coil on the clamp jaw, produce the induction current I_1 , which could be measured by the clamp meter and know the measured current I by the following formula: $I=n \cdot I_1$

Of which: n is the transformer ratio coefficient between secondary and primary coil.

IX、 Ground Resistance Measurement Method

1、 Multi-point Ground System

Multi-point ground system (ex. Electricity Transmission System tower grounding, communication cables grounding system, some buildings etc.) are connected by the overhead ground wires and form into the ground system. As shown in the following picture, when measuring by the clamp meter, the equivalent circuit shall be shown as follows:

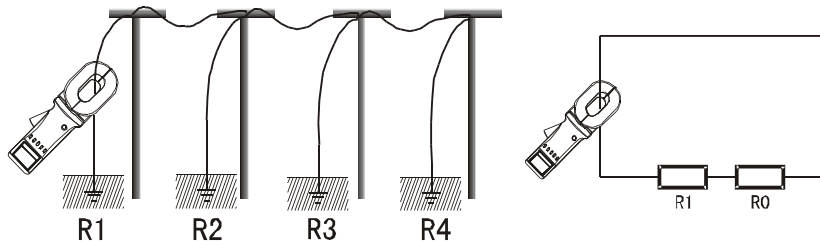

Of which, $R1$ is the estimated ground resistance and $R0$ is the equivalent resistance of all other towers ground resistance in parallel.

From the aspect of strict ground theory, as the existence of the so called “mutual resistance”, $R0$, in general electrical engineering meaning, is not the parallel value (slightly bigger than that of general electrical engineering meaning), but ground hemisphere of each tower is much smaller than the distance between towers and the great number of ground points, $R0$ is much smaller than $R1$. Thus, it is reasonable to speculate $R0=0$ from the engineering aspect and the resistance we measured should be $R1$.

After many comparison tests between tests under different environment, occasions and traditional ways, the above speculation is fully reasonable.

2、 Limited Point Ground System

The circumstance is quite common, for instance, some towers are connected with each other by the over head ground wire; and some building's ground is not an independent ground net but several ground bodies connected with each other by wires.

Under this circumstance, regarding $R0$ in the above picture as 0 shall result in

great errors.

Owing to the same reason, we neglect the impact of mutual resistance and calculate the equivalent resistance of ground resistance in parallel from the general meaning. Thus, for ground system of N (N is small, but bigger than 2) ground bodies, we can list out N formula:

$$R_1 + \frac{1}{\frac{1}{R_2} + \frac{1}{R_3} + \dots + \frac{1}{R_N}} = R_{1T}$$

$$R_2 + \frac{1}{\frac{1}{R_1} + \frac{1}{R_3} + \dots + \frac{1}{R_N}} = R_{2T}$$

$$\dots$$

$$R_N + \frac{1}{\frac{1}{R_1} + \frac{1}{R_2} + \dots + \frac{1}{R_{(N-1)}}} = R_{NT}$$

Of which, R1、R2、……RN is the ground resistance of N ground bodies we need to solve.

R1T、R2T、……RNT are respectively the resistance measured on each ground branch circuit by clamp meter.

This is nonlinear equations with N unknown and N equations. It has certain solution, but which is difficult to solve by manual operations and even impossible when N is quite big.

Purchasing the limited point ground system calculating program software from our company, user shall be able to solve it by using an office computer or laptop. Principally, except for the neglect of mutual resistance, the method would not result in any measurement error brought by neglecting R0.

Users need to pay attention that: the number of connected ground bodies in your ground system shall be exactly equal to that of measurement value for program calculation and the program shall output the same number of ground resistance value.

3、Single Point Ground System

From the test principle, UNIT series clamp meter can only be used to measure loop resistance but the single point ground. However, user can make a loop to test by using a test line and ground polarity near the ground system. Two methods of measuring single point ground by clamp meter are introduce in the following and the method could be applicable to occasions that traditional voltage-current

method fail to measure.

(1)、Two -point method

As shown in the following picture, find an independent ground body RB with good ground near the ground body RA being measured (ex. adjacent metal running water pipe, metal fire hydrant, building etc.) and connect RA with RB by a test line.

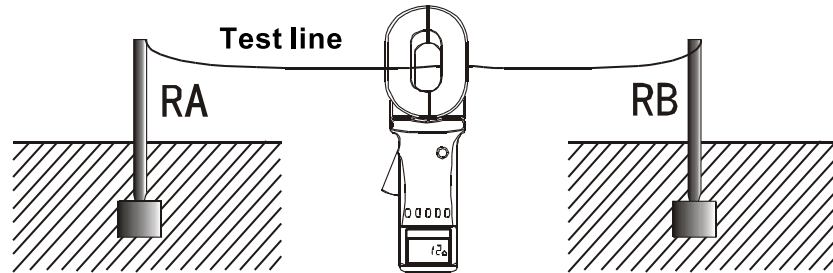

As resistance measured by the clamp meter is the parallel value of 2 ground resistance and test line resistance,

$$RT=RA+RB+RL.$$

Of which, RT is the resistance measured by clamp meter and RL is the resistance

of test line.

Resistance RL could be measured by clamp meter by connecting the test line end to end. If measurement value of clamp meter is smaller than the allowable value of ground resistance, ground resistance of the two ground bodies shall be qualified.

(2)、Three-point method

As shown in the following picture, find two independent ground bodies RB and RC near the ground body RA being measured. If no existing independent ground body, make 2 auxiliary ground polarities with 3-5m distance between them and about 0.7m depth each.

Step1, connect RA and RA with a test line, as shown in the following picture, and read the first data R1 by clamp meter.

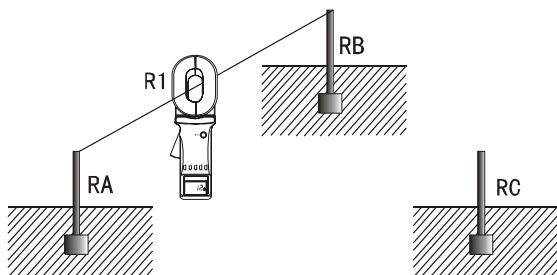

Step2, connect RB and RC with a test line, as shown in the following picture, and read the second data R2 by clamp meter.

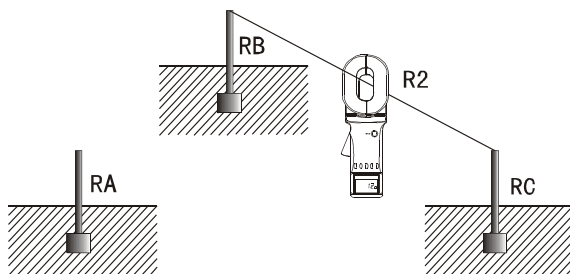

Step3, connect RC and RA with a test line, as shown in the following picture, and read the third data R3 by clamp meter.

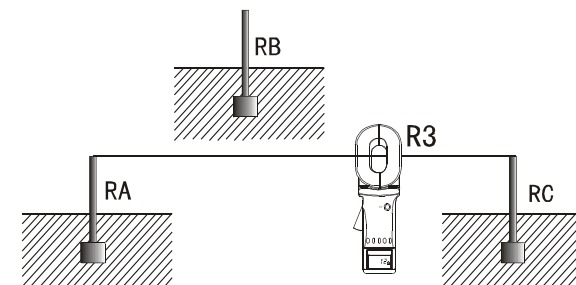

Of the above three steps, reading of each step is the parallel value of two ground resistance, so each ground resistance value can be easily calculated:

$$\text{As: } R1=RA+RB \quad R2=RB+RC \quad R3=RC+RA$$

$$\text{So: } RA= (R1+R3-R2) \div 2$$

This is the ground resistance value of ground body RA. To memorize the above formula easily, the 3 ground bodies could be regarded as a triangle and the resistance being measured equals to the sum of adjacent lines resistance minus

resistance of the opposite line, and then divided by 2.

Ground resistance value of other two reference ground bodies are:

$$R_B = R_1 - R_A \quad R_C = R_3 - R_A$$

X、 On-site Application

1、 Application of Power System

(1). Measurement of the power line tower ground resistance

Generally, the power line tower ground form into multi-point ground system and clamp on the ground down lead by UNIT series clamp meter, the ground resistance value of the branch circuit could be measured.

(2). Measurement of transformer neutral point ground resistance

In measuring the transformer neutral point ground resistance, if data fluctuates greatly, power off and test.

There are two circumstances for the transformer neutral point ground: form into multi-point ground system if repetitive ground exists; single point ground measurement if no repetitive ground.

In measurement, if clamp meter display “L 0.01Ω” , it is possible that more than 2 ground down leads of the same tower or transformer are connected underground. It is need to maintain only one ground down lead, and unfasten others.

(3). Application of power plant and substation

UNIT series clamp meter can test the loop contact and connect condition and can measure the connection between equipment in the station with the ground net by a test line. The ground resistance could be measured as the single point ground.

2、 Application of Telecommunication System

(1). Ground resistance measurement of the floor computer room

The computer room of the telecommunication system is always established on the upper floor of building, difficult to measure by tramegger. While it is quite easy for UNIT series clamp meter to test, just connecting a test line with fire hydrant and the ground polarity being measured (each computer room is equipped with fire hydrant) and measuring the test line with clamp meter. Clamp resistance value=computer room ground resistance +test line

resistance + fire hydrant ground resistance

If the fire hydrant ground resistance is quite low, computer room ground resistance \approx clamp resistance value - test line resistance

(2). measurement of computer room and launching tower ground resistance

Generally, computer room and launching tower ground form into two-point ground system, as shown in the following picture.

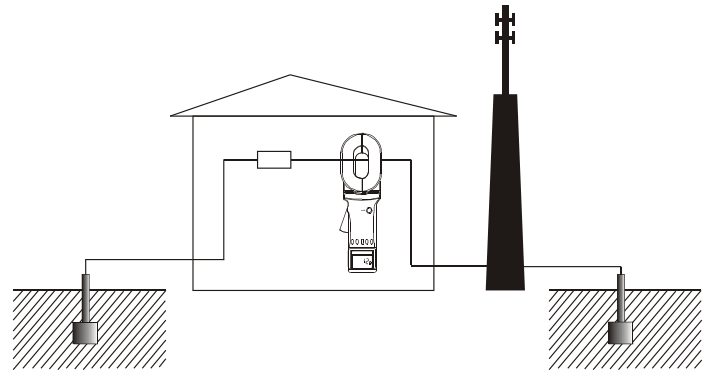

If measurement value of clamp meter is lower than the allowable value of ground resistance, ground resistance of computer room and launching tower shall be qualified. If measurement value of clamp meter is higher than the allowable value, please measure it as the single point ground.

3、Application of the building lightning protection ground system

If ground polarities of building are independent, the ground resistance measurement of each ground polarity shall be referred to the following picture:

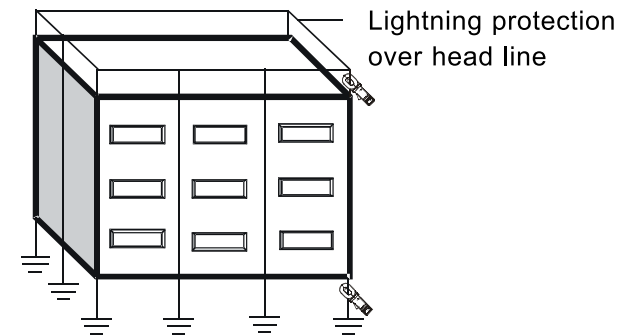

4、Application of the gas station ground system

Under the explosive gas atmosphere, equipment or infrastructure such as gas station, oil field, oil chute etc. shall be equipped with the explosion prevention product.

In accordance with the JJF2-2003 Test Code for Static Protective Ground Device, gas stations shall measure ground resistance and connection resistance of the following infrastructure. The equipment used in measurement shall comply with the requirements in GB3836-2000 Electrical Apparatus for Explosive Gas Atmospheres.

No.	Measurement items	Technical requirements
1	Oil tank ground resistance	$\leq 10 \Omega$
2	Loading point ground resistance	$\leq 10 \Omega$
3	Oil-filling machine ground resistance	$\leq 4 \Omega$
4	Ground resistance of the oil-filling machine oil hose	$\leq 5 \Omega$

explosion-proof mark being Exia II BT3. The clamp can apply to the flammable and explosive atmosphere.

(1)、Oil tank and loading point ground resistance measurement

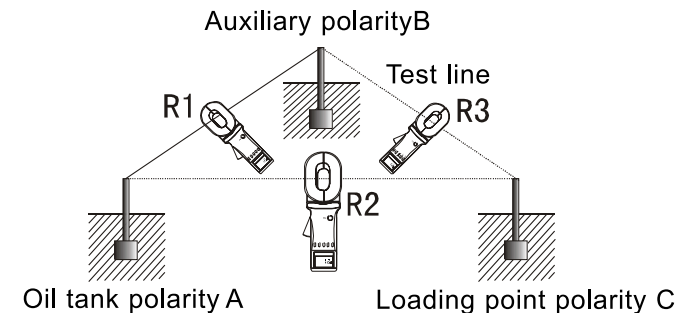

As shown in the above picture, in the gas station ground system, oil tank ground polarity A is connected with oil-filling and the loading point ground polarity C is an independent ground polarity. Find another independent ground polarity as auxiliary ground polarity B (ex. running water pipe) , measure R1、 R2 and R3 in accordance with the three-point method by clamp meter.

We can calculate that:

Oil tank ground resistance: $RA = (R1 + R2 - R3) \div 2$

Loading point ground resistance: $RC = R2 - RA$

Auxiliary polarity ground resistance: $RB = R1 - RA$

Notes: in measuring $R1$, there should be no leading wire between BC and AC and by analogy to $R2$ and $R3$.

(2)、Measurement of the oil-filling ground resistance

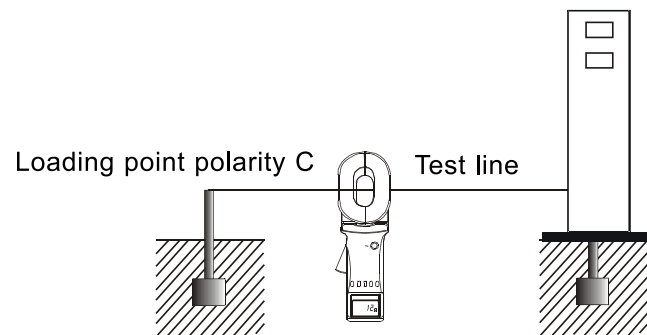

As shown in the above picture, find a ground polarity independent from the oil-filling machine, for instance, loading point polarity. Connect them with test line and read RT with the clamp meter. We can calculate that:

Oil-filling machine ground resistance: $R = RT - RC$

Of which, RT is the resistance value measured by clamp meter, and RC is the loading point ground resistance.

(3)、Measurement of the oil-filling machine oil hose connection resistance

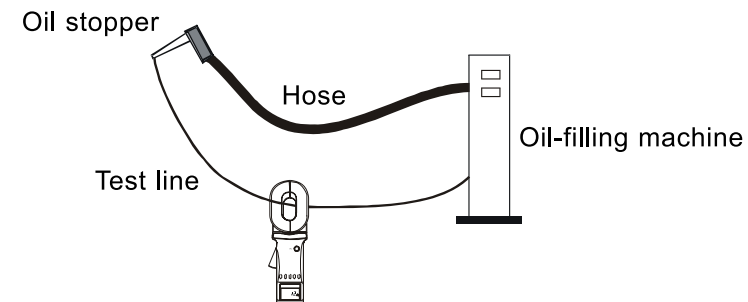

Connect oil stopper with the oil-filling machine by a test line and measure the reading R_T by clamp meter, then calculate:

Oil-filling machine oil hose connection resistance: $R = R_T - R_L$

Of which, R_T is the resistance value measured by clamp meter, and R_L is the test line resistance.

XI、 Notes about Ground Resistance Measurement

1、 If users find great difference after conducting comparative test between the series product and traditional voltage/current method, please pay attention to the following notes:

(1). Find if tripping in using the traditional voltage and current method (if disconnect the ground body being measured from the ground system). If no tripping, the measured ground resistance value is the parallel value of ground resistance of all ground bodies.

It is meaningless to measure the parallel value of ground resistance of all ground bodies, as our purpose of measuring ground resistance is to compare it with an allowable value stipulated by relevant standard, judging whether the

ground resistance is qualified.

For instance: the ground resistance allowable value stipulated in the GB50061-97 Code for Design of 66kV or Under Overhead Electrical Power Transmission Line is designed for Each Tower. It is clearly stated in the standard that: ground resistance of each tower refers to the resistance value measured after disconnecting the electric connection of ground wire from ground body. If the ground body have not been disconnected electric connection of ground wire from ground body, the ground resistance measured shall be the ground resistance of multi-towers in parallel.

The stipulation is clearly stated.

As mentioned above, measured result of the series clamp meter is the ground resistance of each branch circuit, under the condition of good conductivity of the ground wire; it is the ground resistance of single ground body.

It is evident that under the circumstance, it is no comparability of the measurement results tested by the traditional voltage current method and the series clamp meter. As the object being measure is different, the evident difference between measurement results is reasonable.

(2). The ground resistance value measured by the series clamp meter is the

composite resistance of the ground branch circuit, it includes the contact resistance, lead resistance and ground body resistance of the branch circuit to the public ground wire. Value measured by the traditional voltage current method in tripping is only the ground body resistance.

Clearly, the former measurement value is greater than the last one, and the difference reflects the amount of contact resistance between branch circuit and public ground wire.

It is required to specify that ground resistance stipulated in the national standard conclude the ground lead resistance. Noun terms in the DL/T621-1997 AC Electric Equipment Ground states that: the sum of ground resistance of polarity or natural polarity and ground wire resistance is called the ground resistance of ground equipment.

The stipulation is equally stated clearly as in term of lightning prevention, the wire resistance and ground body ground resistance is equivalent.

2、 Selection of the Measurement Point

In some ground systems, as shown in the following picture, you should select a correct measurement point of measure or get different measurement results.

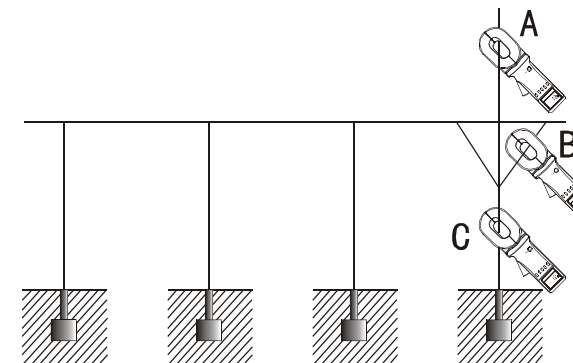

In measuring at point A, the branch circuit measured have not formed into a loop and the clamp meter displays “OL Ω ”, and replace the measurement point.

In measuring at point B, the branch circuit being measured is a loop formed by metal conduct and clamp meter display “L 0.01 Ω ” or the resistance value of metal loop is just few hundredths Ω , quite small, and should replace the measurement point.

In measuring at point C, the branch circuit being measured is the ground resistance value of it.

Appendix: loop Resistance Analysis

Loop resistance includes ground resistance value of point A to the ground, resistance of ground down lead metal conduct, resistance of metal over head wires, connection resistance between the ground down lead and metal over head wires (contact resistance), composite resistance value of point B to the ground, namely the parallel value. The ground net A and B have not been connected underground, requiring different ground net.

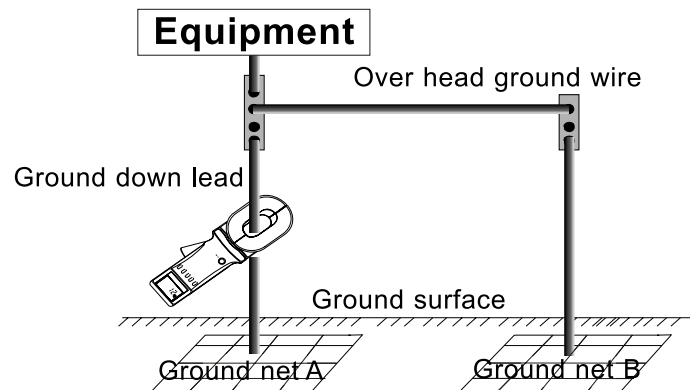

If the parallel value of ground A and B loop measured by 2-point method is 5.0Ω : $R_A + R_B + R$ over head wire $+ R$ ground down lead $= 5.0\Omega$, as over head wires and ground down lead are metal conduct with low resistance, which can be neglected, the real ground resistance value of the ground net A, B in parallel to ground shall definitely $\leq 2.5\Omega$, then we can judge if the real ground resistance value of the ground net A, B in parallel is qualified. If real ground resistance value of the ground net A, B in serial is smaller than the required value of engineer standard, the ground net A, B is all qualified.

The loop resistance test requires that the ground net A, B is different and disconnected with each other underground. If the ground net A, B are connected underground, the metal loop resistance value measured by the meter shall be very small, about few hundredths Ω , not the ground resistance. Thus, the meter is easy to detect the metal loop connection resistance value and equal potential resistance value and applicable to detect the connection and welding between metal loops.

If there is no over head wires between the ground net A and B, namely no metal connection on ground, the ground net A and B is single point ground and shall be tested as the single point ground.

UNI-T®

UT276A/278A OPERATING MANUAL

UNI-T®

UT276A/278A OPERATING MANUAL

The manual information is subject to changes without prior notice!

UNI-T®
UNI-TREND TECHNOLOGY (CHINA) CO., LTD.
No.6, Gong Ye Bei 1st Road,
Songshan Lake National High-Tech Industrial
Development Zone, Dongguan City,
Guangdong Province, China
Tel: (86-769) 8572 3888
<http://www.uni-trend.com>